

w o r l d w i d e

SIET NEON TRANSFORMERS

意大利思盈霓虹灯变压器



MADE IN ITALY

ITALIAN DESIGN EUROPEAN QUALITY

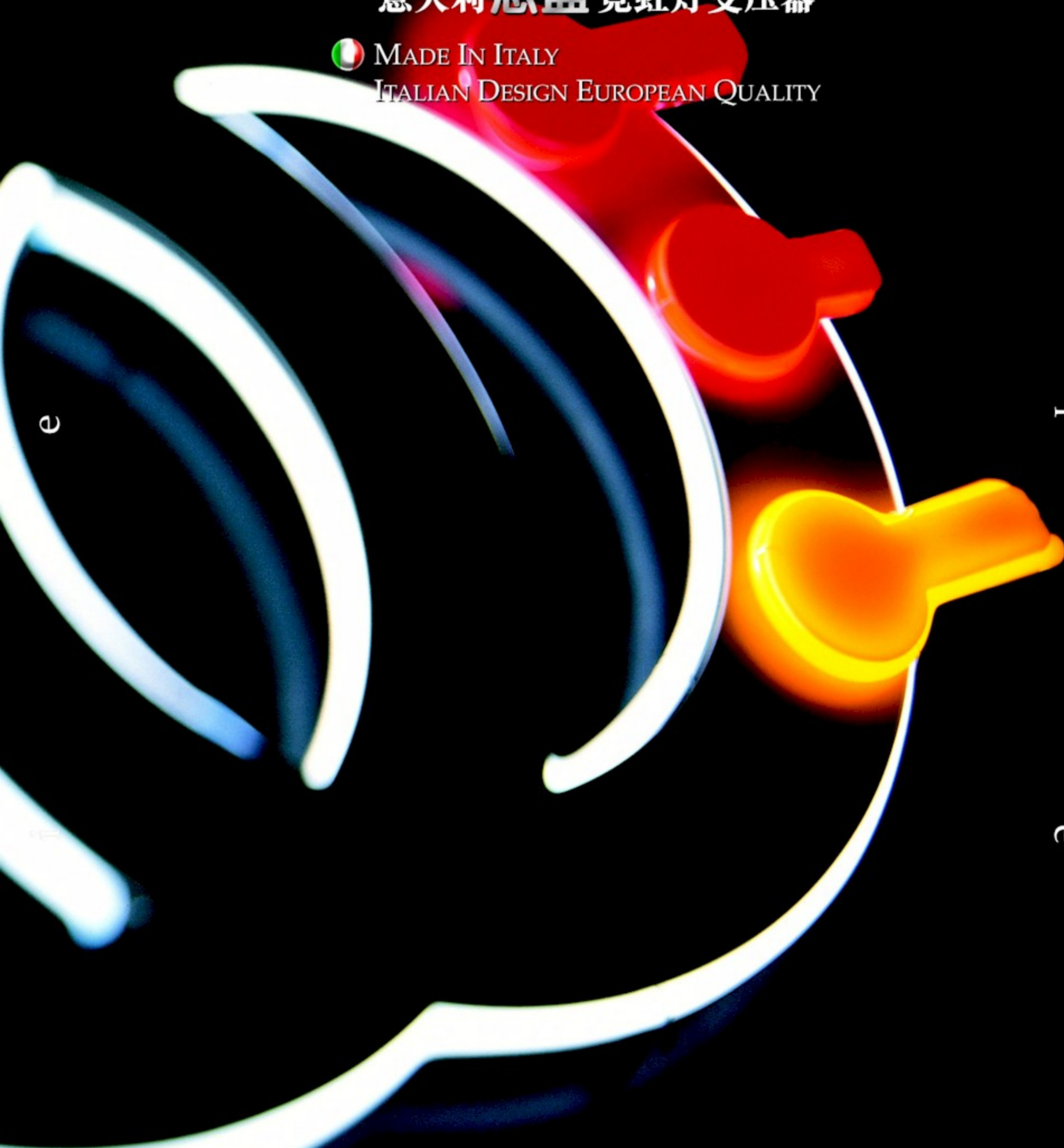

siet

# metalbox<sup>®</sup>

t r a n s f o r m e r s

## 经典型霓虹灯变压器

### Transformers in metallic case patented for outdoor applications IP44 金属外壳的变压器，获得户外应用专利IP44

Transformers are placed inside moulded unwelded metallic boxes patented for outdoor applications IP44, Metalbox is well known world-wide for its high resistance to external agents attack in extreme weather conditions, for its performance and compact shape. Thanks to the electronically controlled atmosphere, the impregnation process under high vacuum with epoxy resin and filling compounds, assures an excellent thermal conductivity and excellent dielectric characteristics. Automatic testing units carried out on 100% of the products digitally, guarantees to deliver goods without defects.

**METALBOX**具有全密封式模制金属的专利外壳，达保护IP44水平，绝对适宜户外使用，加上它的优良特性及紧密结合形态能有效抵御因恶劣天气所导致的侵蚀及损坏，全赖其电子化操作方式及在真空环境下注入环氧树脂，以确保优良的导热性及绝缘，以及全自动化数据测试，保证产品质量完美无瑕。



- ① 在高真空下注入环氧树脂 \* 确保100%绝缘
- ② 低耗磁芯 \* 低发热量(少于50%)减少用电量·已获专利
- ③ 电镀金属盒，涂有聚脂粉  
\*特制金属外壳,持久耐用,有别于一般塑料外壳  
\*防止因热胀冷缩所导致的爆裂
- ④ 同一型号适用于氖气、氩气及汞  
\*比其他牌子只限于一种气体所使用，更加物超所值
- ⑤ ENEC·UL·CE 国际质量认证  
\*ENEC为欧洲最高质量认证
- ⑥ 安全导管护套 \*可伸至变压器内
- ⑦ 保护滑片 \*防止触电
- ⑧ 安全双极刀开关 \*防止触电

- ① Impregnation under high vacuum with epoxy resin with filling compounds
- ② Patented magnetic core at low consumption
- ③ Metal box in electro-galvanised plate and coated with polyester powders
- ④ Suitable for Neon and also Argon/Mercury
- ⑤ ENEC-UL-CE quality marks
- ⑥ Possibility of bringing in conduits inside the transformer
- ⑦ Protecting slider for safety maintenance
- ⑧ Safety bipolar knife switch

# SPECIFICATIONS 产品规格

(*) 230 V 50Hz				LEXABOX		METALBOX	
Type 型号	Sec. Voltage V 次级电压	Case Code 外壳编号	Case Code 外壳编号	Current A (*) 电流	Power W 功率	Current A (*) 电流	Power W 功率
				30 mA		30 mA	
00990 V	0495-E-0495	1B	1B	0.19	26		
02000 V	1100-E-1100	1B	1B	0.33	40	0.33	40
02500 V	1300-E-1300	1B	1B	0.40	50	0.40	50
03000 V	1500-E-1500	1B	1B	0.48	56	0.48	56
04000 V	2000-E-2000	1B	1B	0.58	70	0.58	70
05000 V	2500-E-2500	1M	1M	0.73	85	0.73	85
06000 V	3000-E-3000	1M	1M	0.86	95	0.86	95
07500 V	3750-E-3750	1A	1A	1.00	120	1.00	120
09000 V	4500-E-4500	1A	1A	1.15	140	1.15	140
10000 V	5000-E-5000	2B	2B	1.35	160	1.35	160
12000 V	6000-E-6000	2B	2B			1.60	200
15000 V	7500-E-7500	2M	2M			1.90	230
				60 mA		60 mA	
00990 V	0495-E-0495	1B	1B	0.34	40		
02000 V	1100-E-1100	1B	1B	0.57	70	0.57	70
02500 V	1300-E-1300	1B	1B	0.71	80	0.71	80
03000 V	1500-E-1500	1M	1M	0.84	98	0.84	98
04000 V	2000-E-2000	1A	1A	1.10	120	1.10	120
05000 V	2500-E-2500	1A	1A	1.26	140	1.26	140
06000 V	3000-E-3000	2B	2B	1.57	180	1.57	180
07500 V	3750-E-3750	2B	2B	1.80	215	1.80	215
09000 V	4500-E-4500	2M	2M	2.20	250	2.20	250
10000 V	5000-E-5000	2M	2M	2.50	280	2.50	280
12000 V	6000-E-6000	2A	2A	2.90	360	2.90	360
15000 V	7500-E-7500	2A	2A	3.80	480	3.80	480
				90 mA		90 mA	
02000 V	1000-E-1000	1M	1M			0.83	100
03000 V	1500-E-1500	1A	1A			1.15	140
04000 V	2000-E-2000	2B	2B			1.50	180
05000 V	2500-E-2500	2M	2M			1.90	220
06000 V	3000-E-3000	2M	2M			2.30	260
07000 V	3500-E-3500	2A	2A			2.50	290
08000 V	4000-E-4000	2A	2A			2.80	320
09000 V	4500-E-4500	2S	2S			3.20	370
10000 V	5000-E-5000	2S	2S			3.60	415
				120 mA		120 mA	
02000 V	1000-E-1000	1A	1A			1.10	120
03000 V	1500-E-1500	2B	2B			1.57	170
04000 V	2000-E-2000	2M	2M			2.05	225
05000 V	2500-E-2500	2M	2M			2.43	270
06000 V	3000-E-3000	2A	2A			2.90	320
07000 V	3500-E-3500	2A	2A			3.39	365
08000 V	4000-E-4000	2S	2S			3.80	420
09000 V	4500-E-4500	2S	2S			4.15	465
10000 V	5000-E-5000	2SM	2SM			4.70	510

LEXABOX						METALBOX					
外壳编号 Case Code	阔 W mm	高 H mm	A mm	长 L mm	重量 Weight kg	阔 W mm	高 H mm	A mm	长 L mm	重量 Weight kg	功能损耗 Power loss* watt
1B	84	81	235	255	3,5	84	81	235	255	3,5	18
1M	84	89	235	255	4,3	84	89	235	255	4,3	25
1A	84	102	235	255	5,3	84	102	235	255	5,3	35
2B	113	102	276	295	7,5	113	102	276	295	7,5	38
2M	113	113	276	295	9,40	113	113	276	295	9,40	45
2A	113	133	276	295	13,2	113	133	276	295	13,2	55
2S	113	150	276	295	15,3	113	150	276	295	15,3	65
2SM	140	160	330	370	21	140	160	330	370	21	85

\*Average case values. 平均值

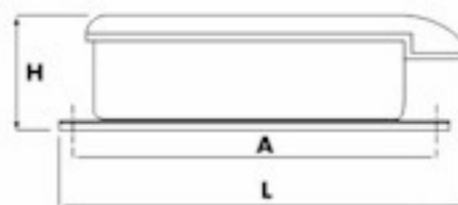
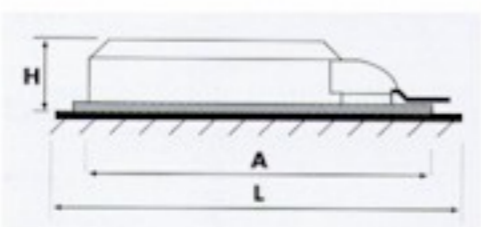
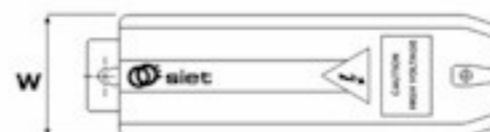
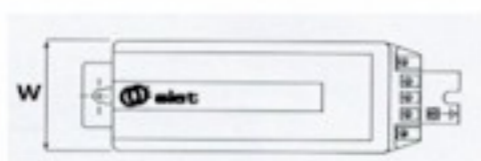

# L E X A B O X

## L I G H T V E R S I O N

### 轻便型霓虹灯变压器

Economic version of transformer in thermoplastic box, suitable for indoor and outdoor applications unprovided of bipolar knife switch

**LEXABOX** 属于经济型的变压器，适用于空气媒介不很活跃的环境中，以同样的变压器放入一个坚固、自动熄灭的塑料外壳中，达IP33保护水平，薄身，外壳为浅色，可供室外及室内使用。

Lexadistop跟Lexabox一样，但内建防止泄漏保护装置 (Distop)

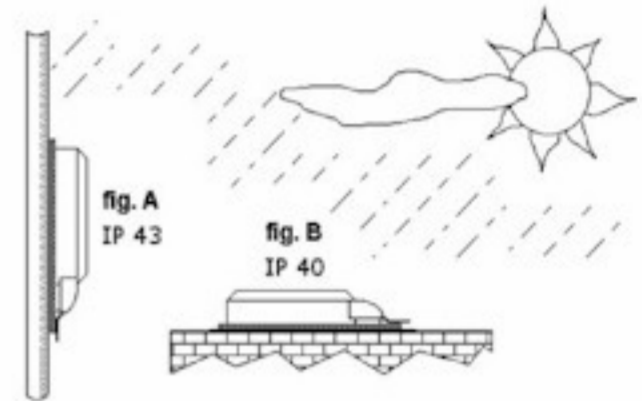

# Electronic power supply



## 新式电子转换器

- \* 纤巧体积
- \* 无水银迁移
- \* 自动调节
- \* 低电压
- \* 达 IP65 保护水平
- \* 适宜户内或户外使用

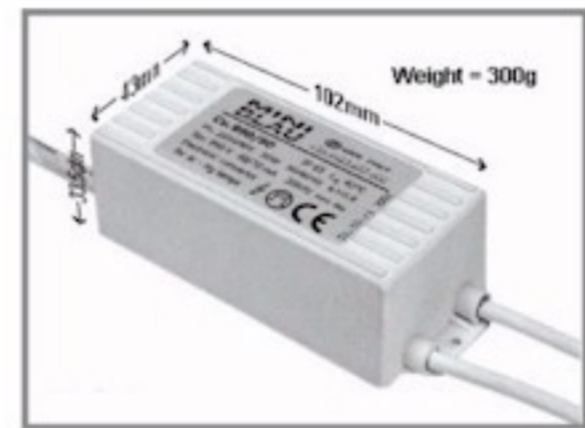

**MINICOMPAK** is an extremely small-in-size neon convertor, designed to provide a stabilised output current. It is ideal for small portable signs as well as channel letters. Available with or without protections in 5000V 25mA or 2500V 50mA.

**MINICOMPAK**是超小型的电子变压器，能稳定输出电流，适用于小型便携式霓虹灯及压克力字，可选内置保护装置，有5000V 25mA及2500V 50mA型号可供选择。



**MINIBLAU** is electronic converters of extreme small size but high power factor, with rated output voltage not exceeding 1kV. Suitable for lighting products not requiring specialist installation techniques and materials.

**MINIBLAU** 是一种超小型但高功率电子变压器，具有额定功率不超过 1kV，内置保险丝，适合霓虹灯及其他照明产品，但不需要专业安装技术和材料。

# Protective Devices 保护装置

## DISTOP 防止泄漏

它能检测高压电路接地的泄露，并且符合在标准 EN50107 规定的运行次数内切断变压器的电源，因此避免了人员伤害和对霓虹灯的损害。

该保护装置有个小型的灌有树脂的外壳，抵制空气媒质，和变压器内接线端子板扣完全吻合。

## INTERSTOP 防止泄露和高压电路切断

INTERSTOP 是一片加插在 Distop 内的组件，用以防止高压开路及低压超载。

INTERSTOP 内置微处理器及 LED 警告灯。

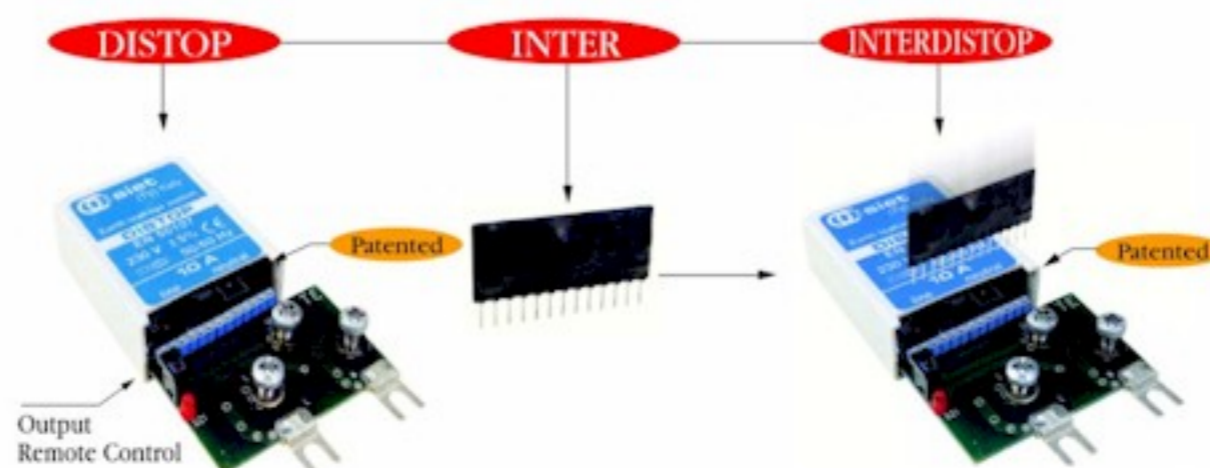

# Dimmer Box 霓虹管/冷阴极管调光器



**Designed for Cold Cathode Lighting**



Dimmer Box 是一款专为Metalbox和Lexabox电感变压器所设计的静态调节系统，有适合3A, 5A, 10A, 30A和50A之初级电流所使用的不同型号供选择。

透过它可控制霓虹变压器的供应电压（由0%至100%）从而调节亮度，通过星型连接法可以带动更多的变压器同时进行调光。

Dimmer Box 所实现的调光方法包括：

- 1) 遥距手动控制挂墙装置。
- 2) 使用感光器自动调节能量。
- 3) 使用PLC(可编程逻辑控制器)编写更适合的调光程序。

Dimmer Box 就是解决光污染问题的最优答案因为它能于特定的时段有效调节光强度，从而减少能源的消耗。

New static regulation system for magnetic transformers type Metalbox and Lexabox, available in 3A, 5A, 10A, 30A and 50A models of primary current.

This device allows a brightness variability through the control of the neon transformer supply tension from 0 to 100%; it can be connected to more than one transformer at a time through the STAR connection boxes until the maximum capacity allowed by the value indicated in the plate.

The dimmeration can be obtained in different ways, depending on the preferences:

1. Manually, through a remote control in a wall embedded box.
2. Through a twilight photocell that can work also as a save energy for the electrical consume reduction
3. Programmable through PLC system: intensity variations are programmed at will.

This system is a valid answer to the problem of luminous pollution because it allows an energetic saving through programming a light intensity reduction at fixed times.

## LED Power Supply

Electronic Supply Control gear for LED modules in SELV (Safety Extreme Low Voltage) IEC 364. Available in 3 models: with output voltage 5V, 10.5V and 24V D.C. For suitable LED modules or other compatible loads short circuit and overload resistant.

### LED 供电器

传动控制式的LED电子供电器，符合IE364 极低电压安全水平，有三款型号可供选择：5V, 10.5V及24V，适合LED或同类型模组。



## LED Power Supply

Full range of advanced LED technology products, such as clocks, displays, standing messages, queuing systems, mini displays and counters.

### LED 产品

全系列先进科技产品如时钟, 轮候系统, 条型显示屏等。



## Cables and Supports



灯脚



硅胶、PVC电缆

Full range of high voltage cables according to EN 50143, UI marked and other, and supports in polycarbonate available in different sizes, in black or transparent color.

### 电缆及灯脚

全系列高压电缆，符合标准En50107及UL认证。霓虹灯脚-聚脂塑料所制，有透明或黑色及不同尺寸供选择。



**BrolloSiet srl**  
 Via Mazzini, 24  
 31031 Caerano San Marco (Treviso) - Italy  
 Tel. ++39 0423 657602  
 Fax ++39 0423 650337  
 E-mail: com@brollosiet.com  
 www.siettransformer.com

**BEST SUPPLY LTD.**  
 香港办事处:  
 九龙弥敦道555号九龙行  
 16楼1602室  
 Unit 1602, 16/F., Kowloon Bldg.,  
 555 Nathan Road,  
 Kowloon, Hong Kong  
 Tel. +852 25200086  
 Fax +852 25200071

**比诚广告器材有限公司**  
 国内办事处:  
 上海浦东新区樱花路801弄  
 23号102室  
 邮编: 201204  
 电话: 021-50596271  
 传真: 021-50596272

**SIET FACTORY - LOCATION**



**SIET WORLD**



网址: <http://www.siet.com.cn>  
<http://www.bestsupply.com.hk>  
 电邮: [china1@bestsupply.com.hk](mailto:china1@bestsupply.com.hk)  
[info@siet.com.cn](mailto:info@siet.com.cn)